

Approval body for construction products  
and types of construction

Bautechnisches Prüfamt

An institution established by the Federal and  
Laender Governments



## European Technical Assessment

ETA-13/0076  
of 14 July 2022

English translation prepared by DIBt - Original version in German language

### General Part

Technical Assessment Body issuing the  
European Technical Assessment:

Deutsches Institut für Bautechnik

Trade name of the construction product

Punching reinforcement Schöck Bole®

Product family  
to which the construction product belongs

Double headed studs for increase of punching shear  
resistance of flat slabs or footings and ground slabs

Manufacturer

Schöck Bauteile GmbH  
Vimbucher Straße 2  
76534 Baden-Baden (Steinbach)

Manufacturing plant

Schöck Manufacturing Plants

This European Technical Assessment  
contains

14 pages including 2 annexes which form an integral part  
of this assessment

This European Technical Assessment is  
issued in accordance with Regulation (EU)  
No 305/2011, on the basis of

EAD 160003-00-0301, Edition 05/2018

This version replaces

ETA-13/0076 issued on 12 March 2018

The European Technical Assessment is issued by the Technical Assessment Body in its official language. Translations of this European Technical Assessment in other languages shall fully correspond to the original issued document and shall be identified as such.

Communication of this European Technical Assessment, including transmission by electronic means, shall be in full. However, partial reproduction may only be made with the written consent of the issuing Technical Assessment Body. Any partial reproduction shall be identified as such.

This European Technical Assessment may be withdrawn by the issuing Technical Assessment Body, in particular pursuant to information by the Commission in accordance with Article 25(3) of Regulation (EU) No 305/2011.

## Specific Part

### 1 Technical description of the product

The Schöck Bole® double headed studs with ribbed shafts are made of weldable ribbed reinforcement bars with nominal characteristic yield strength of 500 MPa. The mechanical properties of the steel fulfill the requirement according to EN 1992-1-1, Annex C.

They have a head at both ends with a diameter of three times the shaft diameter.

The diameters of the shafts are 10, 12, 14, 16, 20 and 25 mm.

The studs are assembled to form reinforcement elements comprising at least two studs (s. figure 1). The studs are tack welded or clamped at one end to a non-structural steel rail or steel bars (reinforcing bars or round bars) for securing the position of the double headed studs when pouring the concrete. They also may be tack welded or clamped to steel bars at the shaft. In this case the bars shall have a diameter of  $d_s = 6$  mm (for studs with diameter  $d_A < 20$  mm) and  $d_s = 8$  mm (for studs with  $d_A \geq 20$  mm). For use in semi-prefabricated slabs only, plastic bars and special plastic clips are used to secure the placement during casting. All studs of one of those reinforcement element shall have the same diameter.

The bars used to secure the stud's position during casting (assembling bars or -rails) are made of weldable reinforcing steel  $d_s = 6$  mm to  $d_s = 10$  mm or structural steel (smooth steel bars)  $d_s = 6$  mm to  $d_s = 8$  mm and the rails are made of structural steel. The Material for the structural steel (bars or rails) shall be acc. to EN 10025-2 or non-corrosive steel acc. to EN 10088-5 or acc. EN 10088-3 or according technical documentation. The material of the plastic bars and plastic clips for use in semi-prefabricated slabs is specified within the technical documentation deposited with Deutsches Institut für Bautechnik.

The detailed product description is given in Annex A.

### 2 Specification of the intended use in accordance with the applicable European Assessment Document

The performances given in Section 3 are only valid if the Product is used in compliance with the specifications and conditions given in Annex B.

The verifications and assessment methods on which this European Technical Assessment is based lead to the assumption of a working life of the Product of at least 50 years. The indications given on the working life cannot be interpreted as a guarantee given by the producer, but are to be regarded only as a means for choosing the right products in relation to the expected economically reasonable working life of the works.

### 3 Performance of the product and references to the methods used for its assessment

#### 3.1 Mechanical resistance and stability (BWR 1)

Essential characteristic	Performance
Increasing factor for punching shear resistance	$k_{pu,sl} = 1,96$ $k_{pu,fo} = 1,50$
characteristic fatigue strength for $N = 2 \cdot 10^6$ load cycles	$\Delta\sigma_{Rsk,n=2 \cdot 10^6} = 70$ MPa

### 3.2 Safety in case of fire (BWR 2)

Essential characteristic	Performance
Reaction to fire	class A1

### 4 Assessment and verification of constancy of performance (AVCP) system applied, with reference to its legal base

In accordance with EAD No. 160003-00-0301 the applicable European legal act is: [97/597/EC(EU)].

The system(s) to be applied is (are): [1+]

In addition, with regard to reaction to fire for products covered by this EAD the applicable European legal act is: [2001/596/EC(EU)]

The system to be applied is: [4]

### 5 Technical details necessary for the implementation of the AVCP system, as provided for in the applicable EAD

Technical details necessary for the implementation of the AVCP system are laid down in the control plan deposited with Deutsches Institut für Bautechnik.

The following standards and documents are referred to in this European Technical Assessment:

EN 10025-2: 2019-10	Hot rolled products of structural steels - Part 2: Technical delivery conditions for non-alloy structural steels
EN 206-1: 2000	Concrete - Specification, performance, production and conformity
EN 1992-1-1: 2004 + AC:2010	Design of concrete - Part 1 -1: General rules and rules for buildings
EN 100888-3: 2014-12	Stainless steels – Part 3: Technical delivery conditions for semi-finished products, bars, rods, wire, sections and bright products of corrossions resisting for general purposes
EN 100888-5: 2009-07	Stainless steels – Part 5: Technical delivery conditions for semi-finished products, bars, rods, wire, sections and bright products of corrossions resisting for construction purposes
EOTA TR 060: 2017-11	Increasing the punching shear resistance of flat slaps or foundation and floor slaps – double- headed anchor- calculation methods

Issued in Berlin on 14 July 2022 by Deutsches Institut für Bautechnik

Dipl.-Ing. Beatrix Wittstock  
Head of Section

*beglaubigt:*  
Schüler

### Material of stud:

- reinforcing steel with  $f_{yk} \geq 500 \text{ N/mm}^2$  acc. to EN 1992-1-1, Annex C and provided data sheet.

### Dimensions:

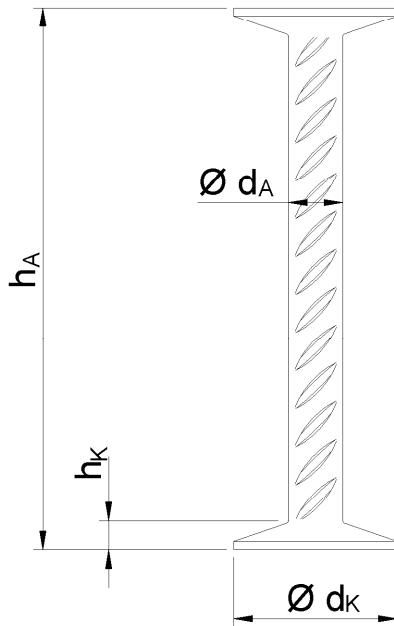

### Marking:

S : symbol of manufacturing plant  
20 : example for stud- $\varnothing 20$

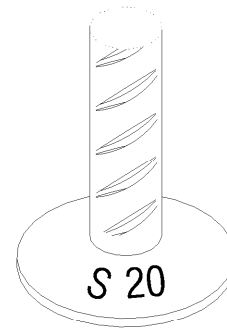

stud diameter $d_A$ [mm]	head diameter $d_K$ [mm]	head thickness min. $h_K$ [mm]	cross section area $A_A$ [mm <sup>2</sup> ]	load capacity $F_{Rk} = A_A \cdot f_{yk}$ [kN]	studheight $h_A$ [mm]
10	30	5	79	39,27	$h_A = h - c_o - c_u$ h : slabthickness c <sub>o</sub> : upper concrete cover c <sub>u</sub> : lower concrete cover
12	36	6	113	56,55	
14	42	7	154	76,97	
16	48	7	201	100,53	
20	60	9	314	157,08	
25	75	12	491	245,44	

### Punching reinforcement Schöck Bole®

**Product description**  
Dimensions and load capacity of double headed studs

Annex A1

## Mounting bar made of reinforcing or round steel

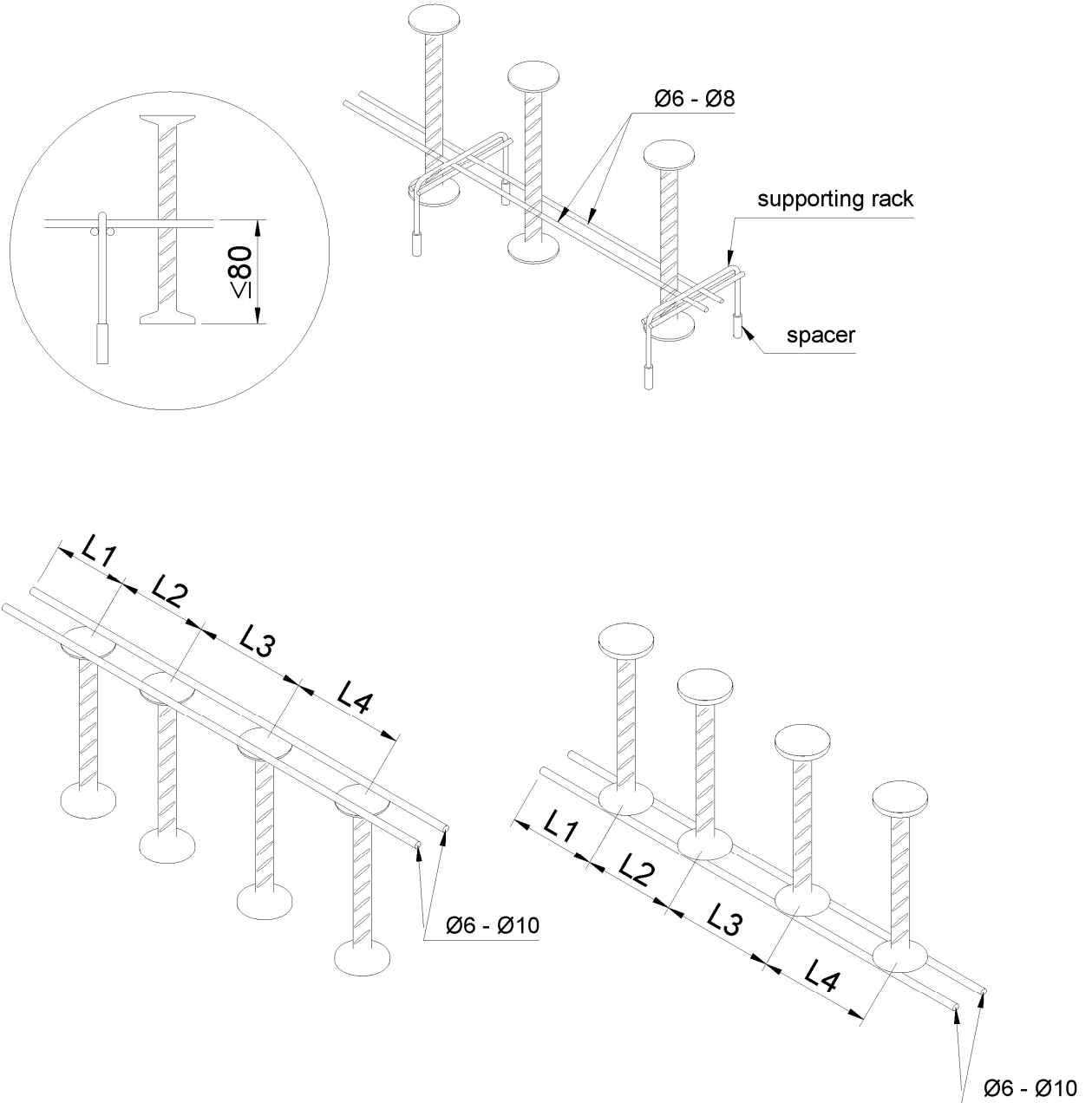

### Materials for mounting bar

- B500 A/B according to EN 1992-1-1, Annex C and data sheet
- B500 NR or stainless round steel according to EN 1993-1-4, EN 10088-3 and EN 10088-5
- Construction steel according to EN 10025-2 and data sheet

Unit [mm]

### Punching reinforcement Schöck Bole®

**Product description**  
Materials and arrangement mounting bars

Annex A2

### Mounting rail made of flat steel

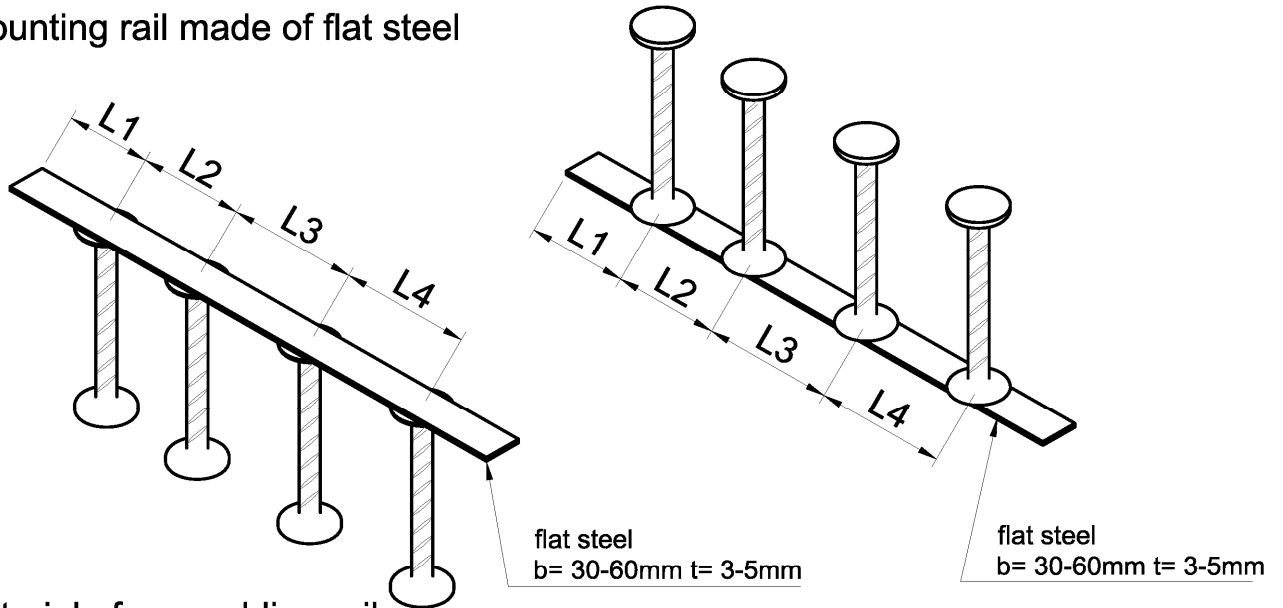

### Material of assembling rail:

- Stainless steel according to EN 1993-1-4, EN 10088-3 and EN 10088-5
- Structural steel according to EN 10025-2 and data sheet

### Assembling bar made of plastic and steel for prefabricated ceiling

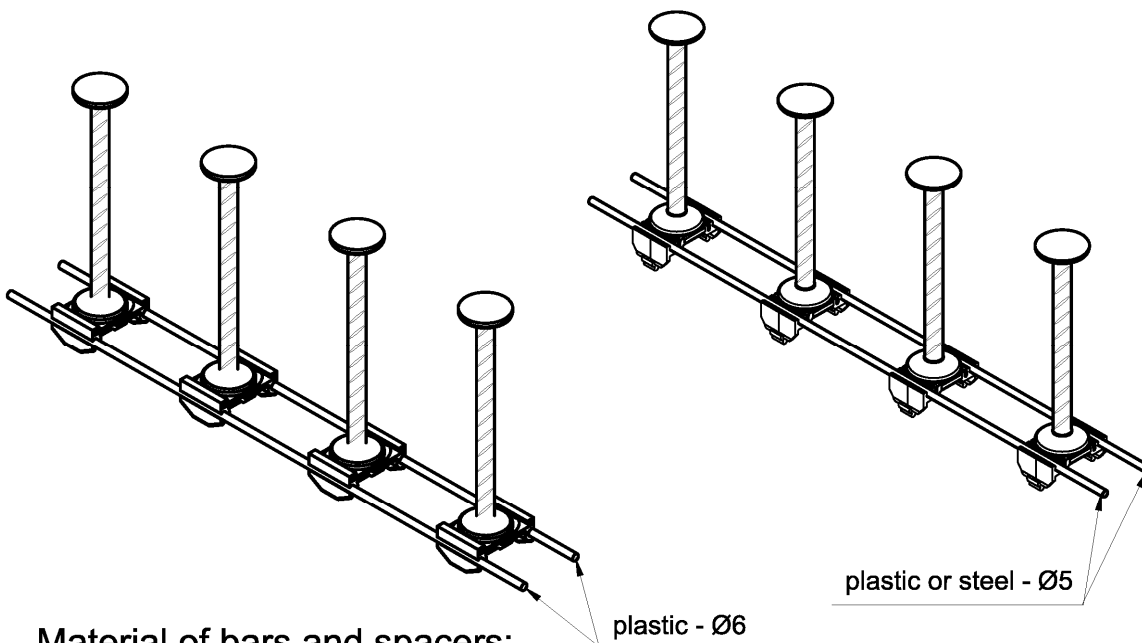

### Material of bars and spacers:

- plastic according to data sheet
- Structural steel according to EN 10025-2 and data sheet

Unit [mm]

### Punching reinforcement Schöck Bole®

#### Product description

Materials and design of mounting rails made of flat steel or plastic

Annex A3

### Design of Schöck Bole®

Due to the symmetric design of the Schöck Bole element, the radial distances between the studs can be assured, if several elements are placed in one row. The first element starts at the face of the column.

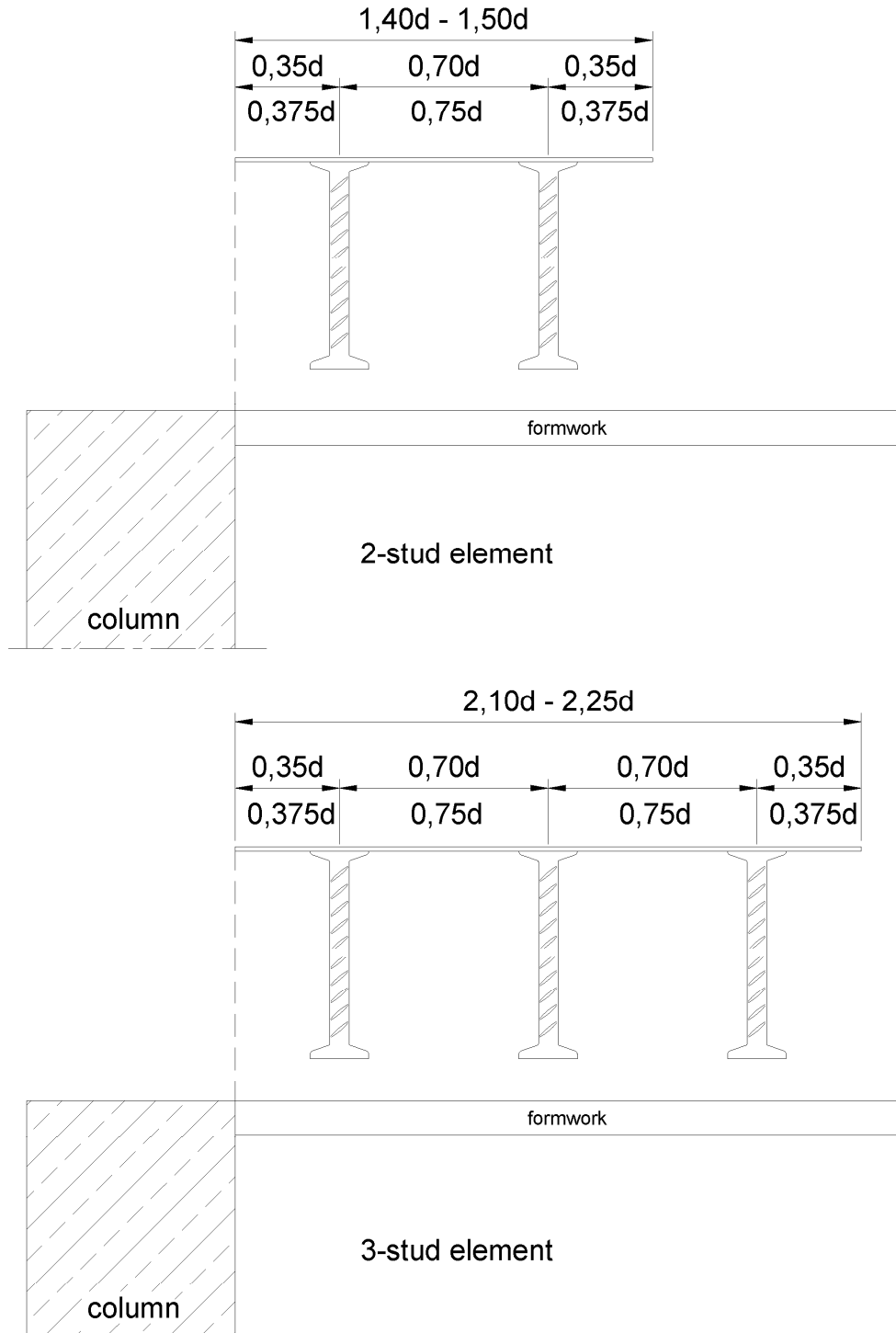

**Punching reinforcement Schöck Bole®**

**Product description**  
Design of the reinforcement element

Annex A4



## Specification of intended use

The double headed studs are used to increase the punching shear resistance of flat slabs, ground slabs and footings under static, quasi-static and fatigue loading. The calculation of the punching shear resistance and the arrangement of the double headed studs is done in accordance with EOTA TR 060.

The intended use covers the following specifications:

- flat slabs, footings and ground slabs made of reinforced normal weight concrete of strength class C20/25 to C50/60 according to EN 206-1:2000
- flat slabs, footings and ground slabs with a minimum height of  $h = 180$  mm
- reinforcement elements with double headed studs of the same diameter in the punching area around a column or high concentrated load
- reinforcement elements with double headed studs installed in an upright (rail at the bottom of the slab) or hanging position
- reinforcing steel for the studs according to EN 1992-1-1 may be used with  $f_{yk} \geq 500$  N/mm<sup>2</sup>, in design only  $f_{yk} = 500$  N/mm<sup>2</sup> is allowed
- reinforcement elements with double headed studs positioned such that the double headed studs are perpendicular to the surface of flat slab, footing or ground slab
- reinforcement elements with double headed studs directed radially towards the column or high concentrated load and distributed evenly in the critical punching area
- reinforcement elements with double headed studs positioned such that the upper heads of the studs reach at least to the outside of the uppermost layer and the lower heads of the studs reach at least to the uppermost layer of the flexural reinforcement
- reinforcement elements with double headed studs positioned such that the concrete cover complies with the provisions according to EN 1992-1-1
- reinforcement elements with double headed studs positioned such that the minimum and maximum distances between the double headed studs on an element and between the elements as arranged around a column or area of high concentrated load complies with the provisions according to EOTA TR 060, section 3
- The provisions according to EOTA TR 060, section 3 are kept on site with an accuracy of  $0,1 h$  ( $h$  height of the slab)
- reinforcement elements with double headed studs can also be used for semi-prefabricated slabs in combination with lattice girders, if the respective ETA's or national guidelines are observed. Double headed studs are also effective as bond reinforcement between precast and in-situ concrete.

**Punching reinforcement Schöck Bole®**

Intended use  
Specification

Annex B1

## Installation of double headed studs

- When installed correctly, the double headed studs have sufficient robustness to resist usual actions before and during concreting.
- When the double headed studs are used in semi-prefabricated slabs, there aren't requirements in terms of robustness as mentioned before, if safe transport and positioning is ensured.
- If semi-prefabricated slabs need to be joined in the punching area, the recess between the prefabricated elements shall be at least 40 mm wide and has to be carefully filled with concrete on site.
- In the punching area the semi-prefabricated slabs can be put on the column up to 10 mm or placed with a joint to the edge of the column up to 40 mm. Therefore, the following requirements shall be considered on site:
  - The joint in the compression zone between the semi-prefabricated plate and the column have to be filled up carefully with appropriate concrete of the same strength as the in-situ concrete.
  - The provisions for the distances between the double headed studs and the edge of the column have to be observed.
  - If the semi-prefabricated plate is put on the column, the joint between the plate and the column have to be filled with mortar, in order to transfer the loads from upper floors reliably.
  - The concrete of the semi-prefabricated plates must not be damaged due to chiselling work.
  - The concrete has to be compacted carefully in the bearing area.
  - The upper edge of the previously concreted column shall be below the bottom edge of the semi-prefabricated slab.

## Transport and storage

Special considerations shall be given to the transport of prefabricated elements to avoid any damage to the anchorage of the headed studs in the pre-cast concrete slab. (see Annex B6)

**Punching reinforcement Schöck Bole®**

Intended use  
Specification

Annex B2

### Schöck Bole® for assembling in prefabricated slabs

Type: Schöck Bole® elements with mounting bars are placed on lattice girders

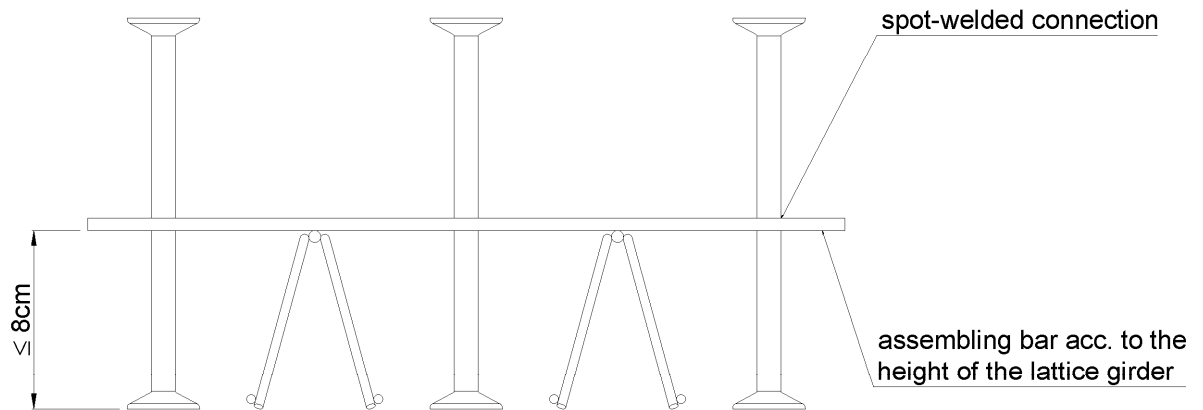

### Material of assembling bars:

- B500 A/B according to EN 1992-1-1, Annex C and data sheet
- B500 NR or stainless round steel according to EN 1993-1-4, EN 10088-3 and EN 10088-5
- structural steel according to EN 10025-2 and data sheet

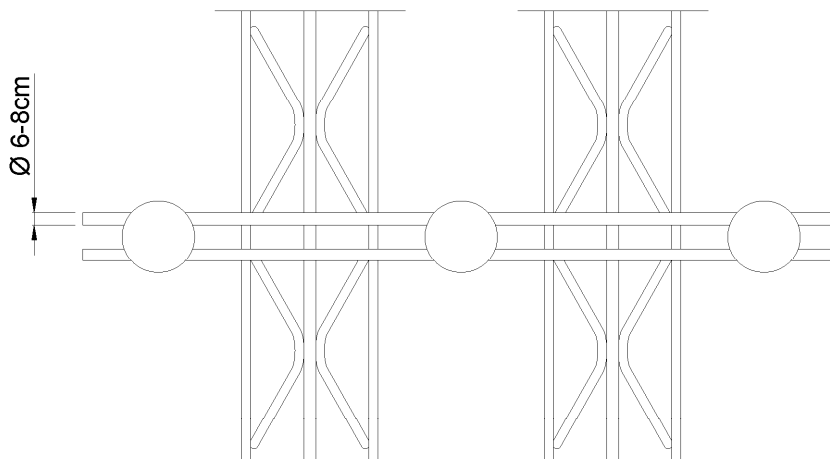

### Punching reinforcement Schöck Bole®

**Intended use**  
Installation of reinforcement elements in prefabricated slabs

Annex B3

## Installation of Schöck Bole® with welded mounting bars in prefabricated slabs

Schöck Bole® elements are placed with the mounting bars at the lattice girder

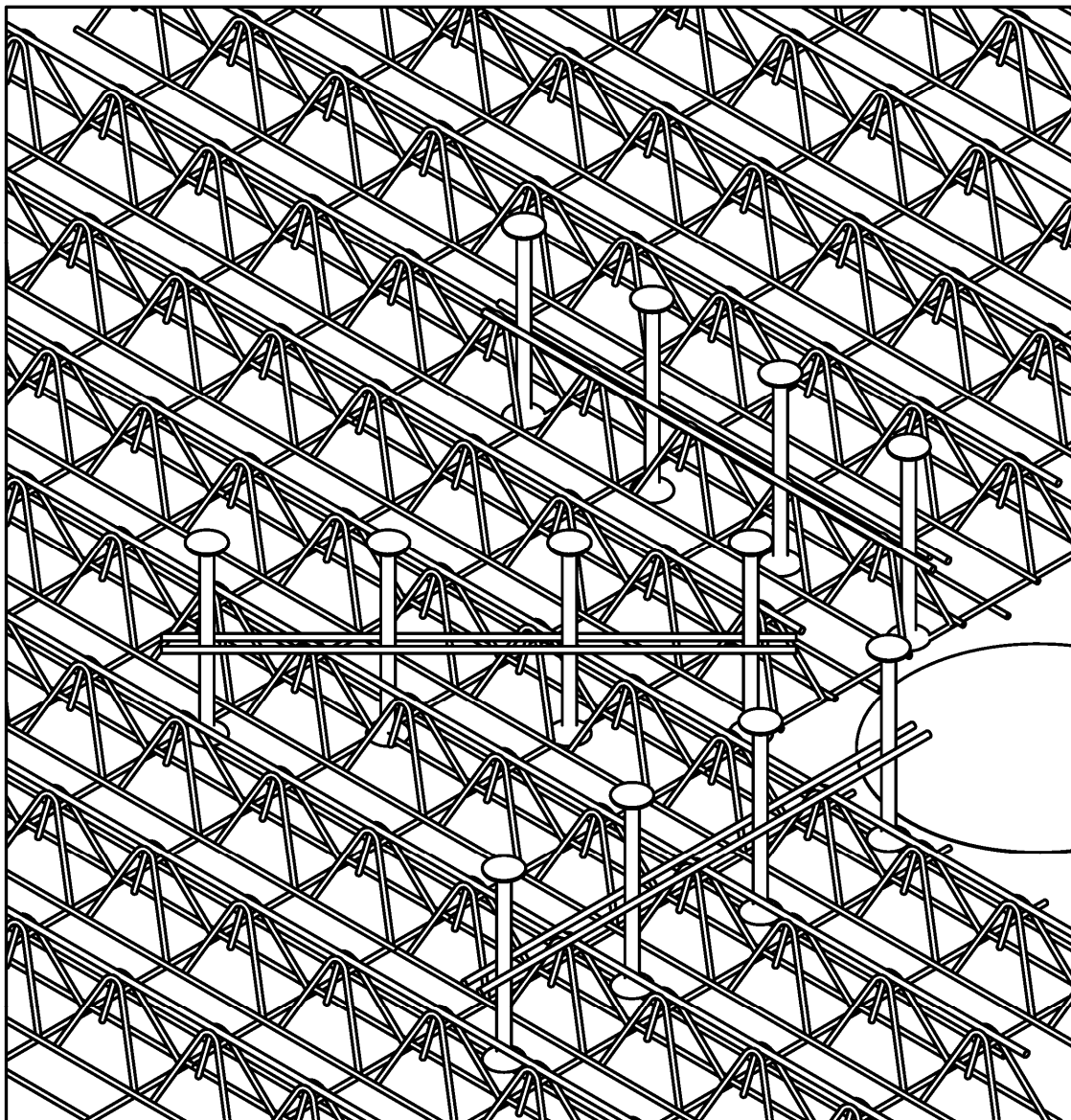

**Punching reinforcement Schöck Bole®**

**Intended use**

Installation of reinforcement elements in prefabricated slabs

Annex B4

## Placing of Schöck Bole® with mounting rail made of plastic in prefabricated flat

Separate installation of mounting rail below the reinforcement bars and double headed studs after placing of reinforcement bars

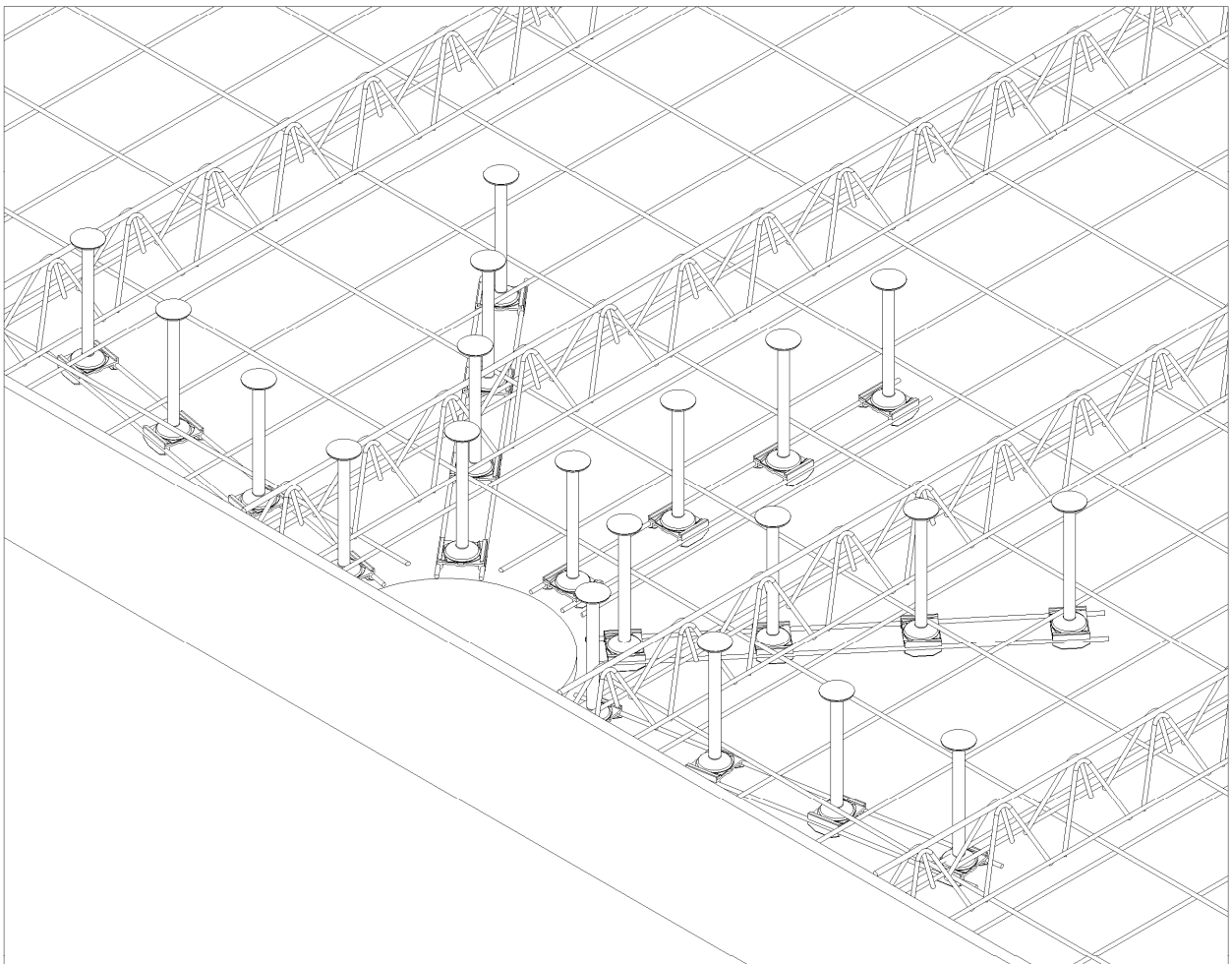

### Punching reinforcement Schöck Bole®

**Intended use**  
Installation of reinforcement elements in prefabricated slabs

Annex B5

## Example of bearing and transport of prefabricated ceiles with Schöck Bole®

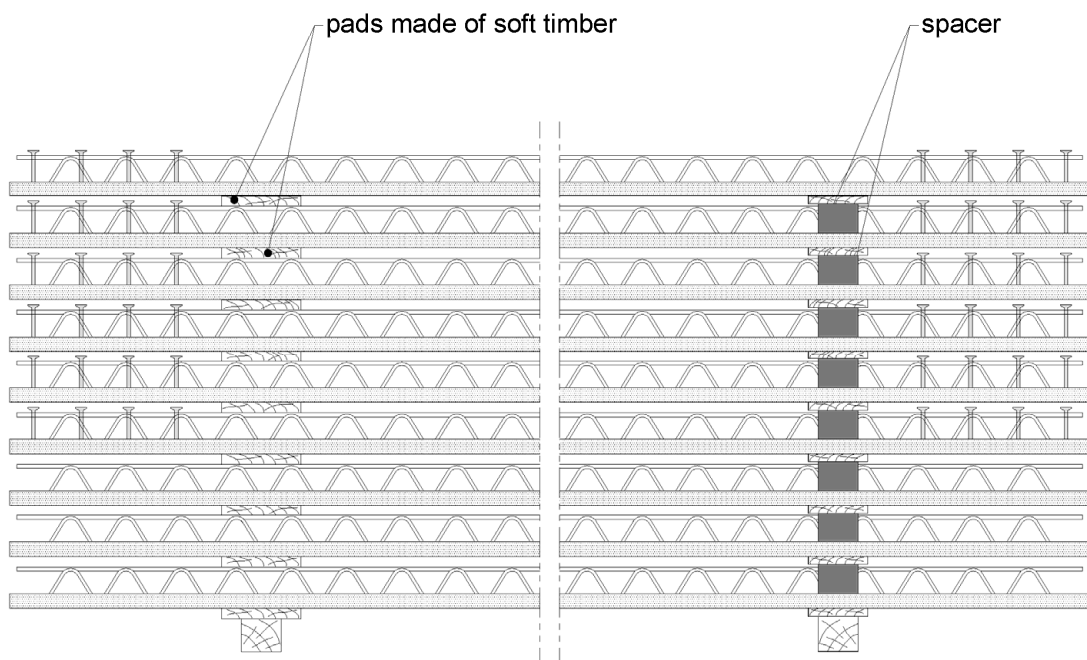

**Punching reinforcement Schöck Bole®**

**Intended use**  
Storage and transport

Annex B6